

CBM[®]

City Building Material CO., LTD
No.132, Let Wel Thondara U Myat San St., East Dagon
Industrial Zone (2), South Dagon Tsp., Yangon, Myanmar
E mail : citybm88@gmail.com

DS-01 PC ROLLER SHUTTER

10 YEARS
PROFESSIONAL IN
PC ROLLER SHUTTER



NAME: HIGH TRANSPARENT POLYCARBONATE ROLLER SHUTTER
MATERIAL:POLYCARBONATE SLAT+STAINLESS STEEL
SIZE: THE MAXIMUM SIZE OF 12M WIDTH AND 6M HIGH

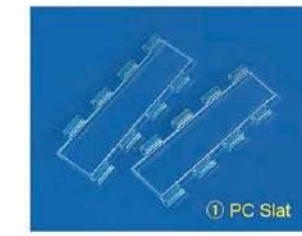
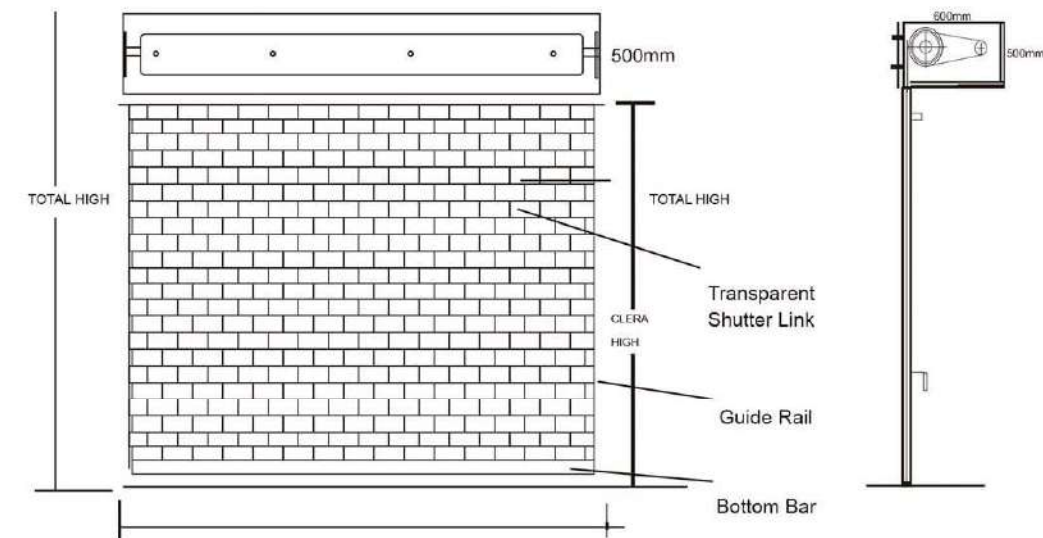

High Quality
Brand

Clear

Fashion



Durable

POLYCARBONATE ROLLER SHUTTER MAKE BY PC SLAT AND STAINLESS STEEL TUBE.
IT HAS HIGH TRANSPARENCY,ANTI-THEFT,ANTI RAIN, SOUND INSULATION,
IT CAN INCREASE STORE EXPOSURE AND DISPLAY ALL THE GOODS TO CUSTOMERS.
SO IT IS VERY WELCOME ON THE SUPERMARKET, BUSINESS MALL AND SHOPS.

ANTI-UV
PC COIL



Professional design according to the door size

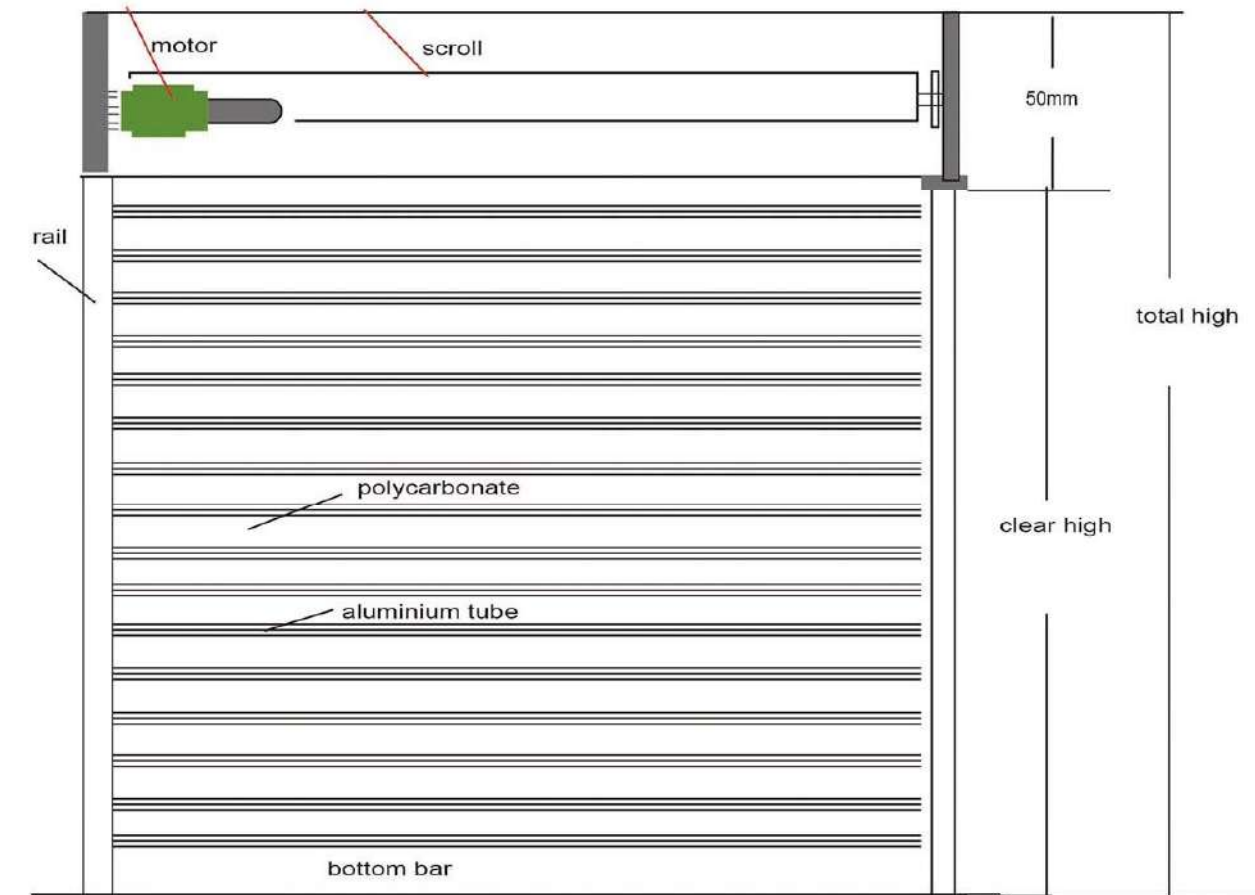

DS-02 PC ROLLER SHUTTER

High Standard and Perfect design

Build a high-end Brand Roller Shutter

NAME: HIGH TRANSPARENT POLYCARBONATE ROLLER SHUTTER

MATERIAL:POLYCARBONATE COIL+ ALUMINIUM ALLOY TUBE

SIZE: THE MAXIMUM SIZE OF 6.8M WIDTH AND 6M HIGH

STRAIGHT POLYCARBONATE ROLLER SHUTTER MAKE BY PC COIL, ALUMINIUM TUBE.

IT HAS HIGH TRANSPARENCY,ANTI-THEFT,ANTI RAIN, SOUND INSULATION,



City Building Material CO., LTD

Professional Design and High-End
DS-03 Folding Door

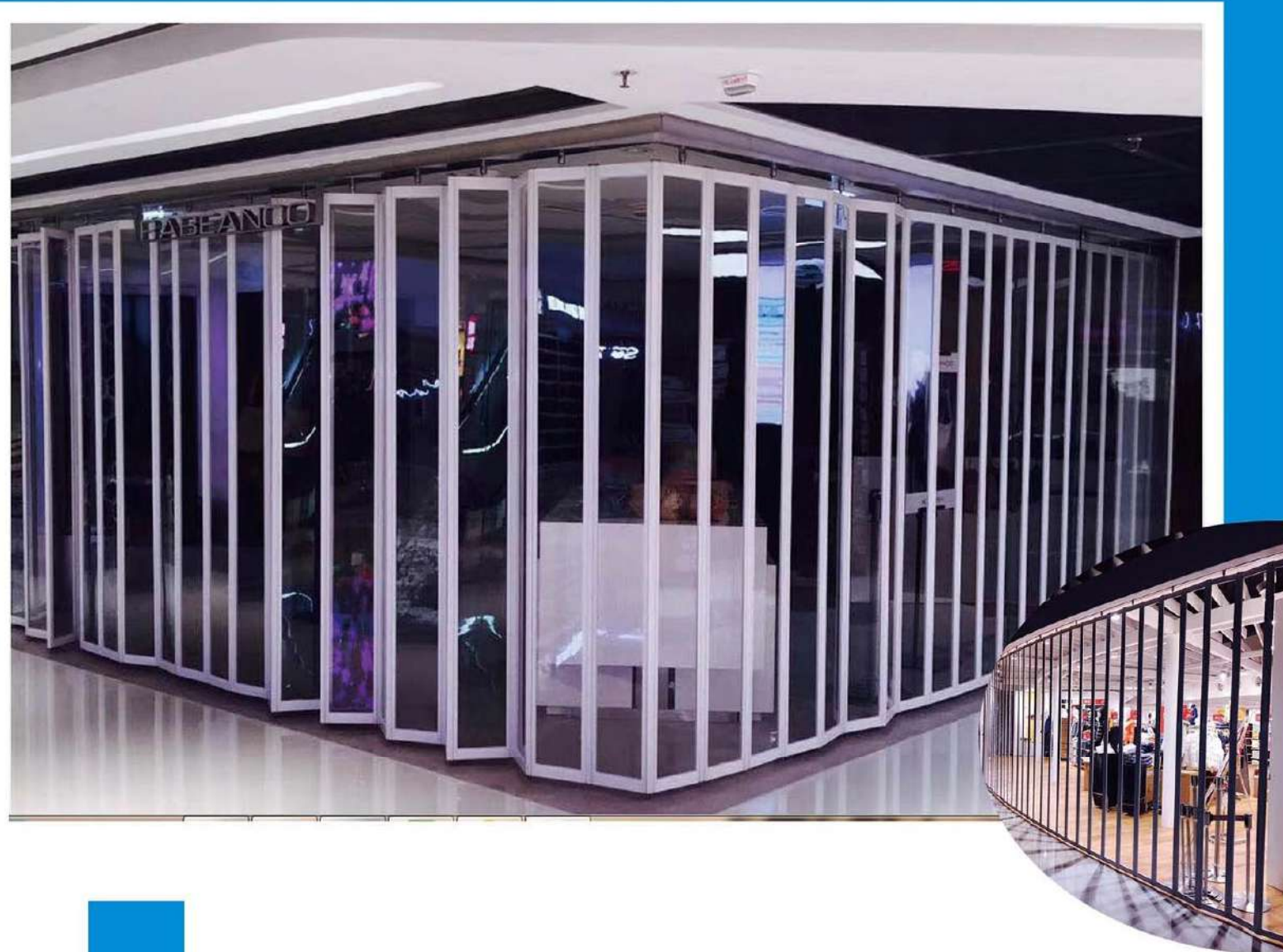

We are focus on manufacturing high quality.
professional design.fashion and welcome
Commercial door for each shop

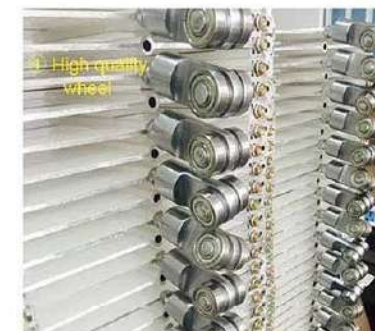
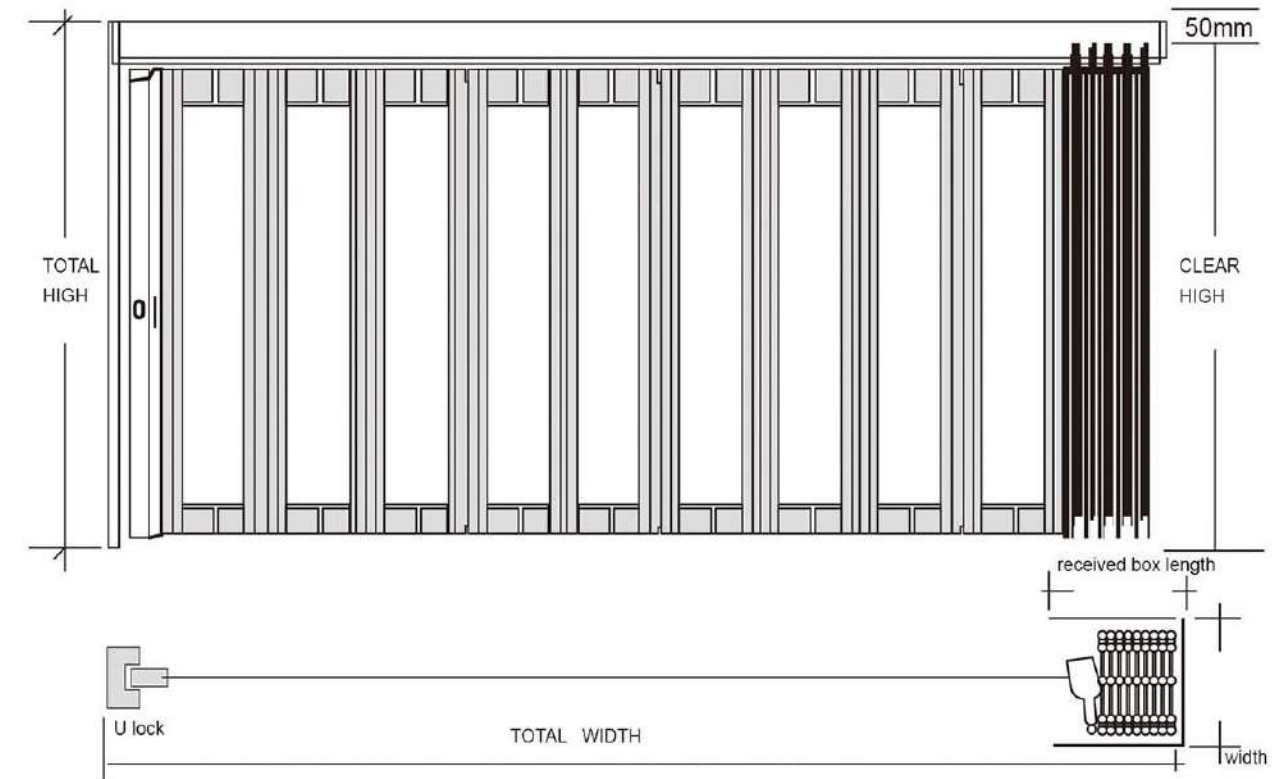

NAME: HIGH TRANSPARENT POLYCARBONATE FOLDING DOOR
MATERIAL:POLYCARBONATE SHEET+ALUMINIUM PANNEL+GUIDE RAIL
SIZE: THE MAXIMUM SIZE OF 30M WIDTH AND 4.5M HIGH BY MANUAL
70M WIDTH AND 4.5M HIGH BY MOTOR OPERATION

POLYCARBONATE FOLDING DOOR MAKE UP BY PC SHEET, ALUMINIUM PANEL,
ALUMINIUM LOCK BAR, HANGING WHEEL, GUIDE RAIL AND MOTOR.
THE CURVE RADIAN IS NOT LESS THAN R600 AND MADE WITHOUT GROUND RAIL

CBM[®]

City Building Material CO., LTD

DS-04 POPULAR AND NEW DESIGN PC SIDE ROLLER SHUTTER

NAME: HIGH TRANSPARENT POLYCARBONATE SIDE ROLLER DOOR

MATERIAL: POLYCARBONATE SLAT+STAINLESS STEEL TUBE+ALUMINIUM LOCK BAR

SIZE: THE MAXIMUM SIZE OF 10M WIDTH AND 5M HIGH BY MANUAL OPERATION

38M WIDTH AND 5M HIGH BY MOTOR OPERATION



Each detail presented with great care

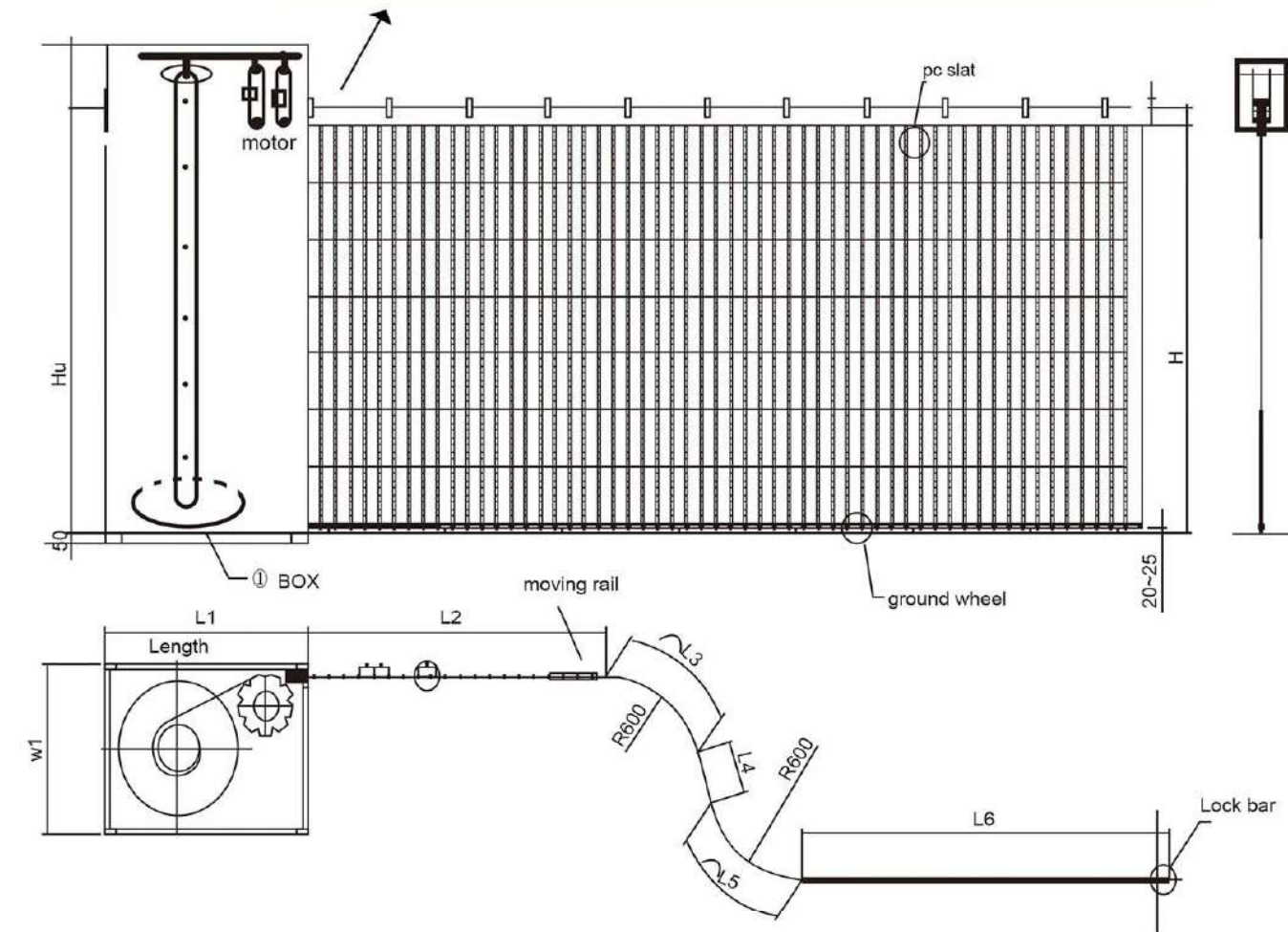

POLYCARBONATE SIDE ROLLER DOOR MAKE UP BY PC SLAT, STAINLESS STEEL TUBE, ALUMINIUM LOCK BAR, STEEL GUIDE RAIL, HANGING WHEEL, SCROLL AND MOTOR. THE CURVE RADIAN IS NOT LESS THAN R600 AND MADE WITHOUT GROUND RAIL.

IT HAS HIGH TRANSPARENCY, ANTI-THEFT, ANTI RAIN, SOUND INSULATION, IT CAN INCREASE STORE EXPOSURE AND DISPLAY ALL THE GOODS TO CUSTOMERS. SO IT IS VERY WELCOME ON THE SUPERMARKET, BUSINESS MALL AND SHOPS.

High quality depends on every process

DS-05 PC ROLLER SHUTTER AND WINDOW



Fashion and New Design PC Roller Window

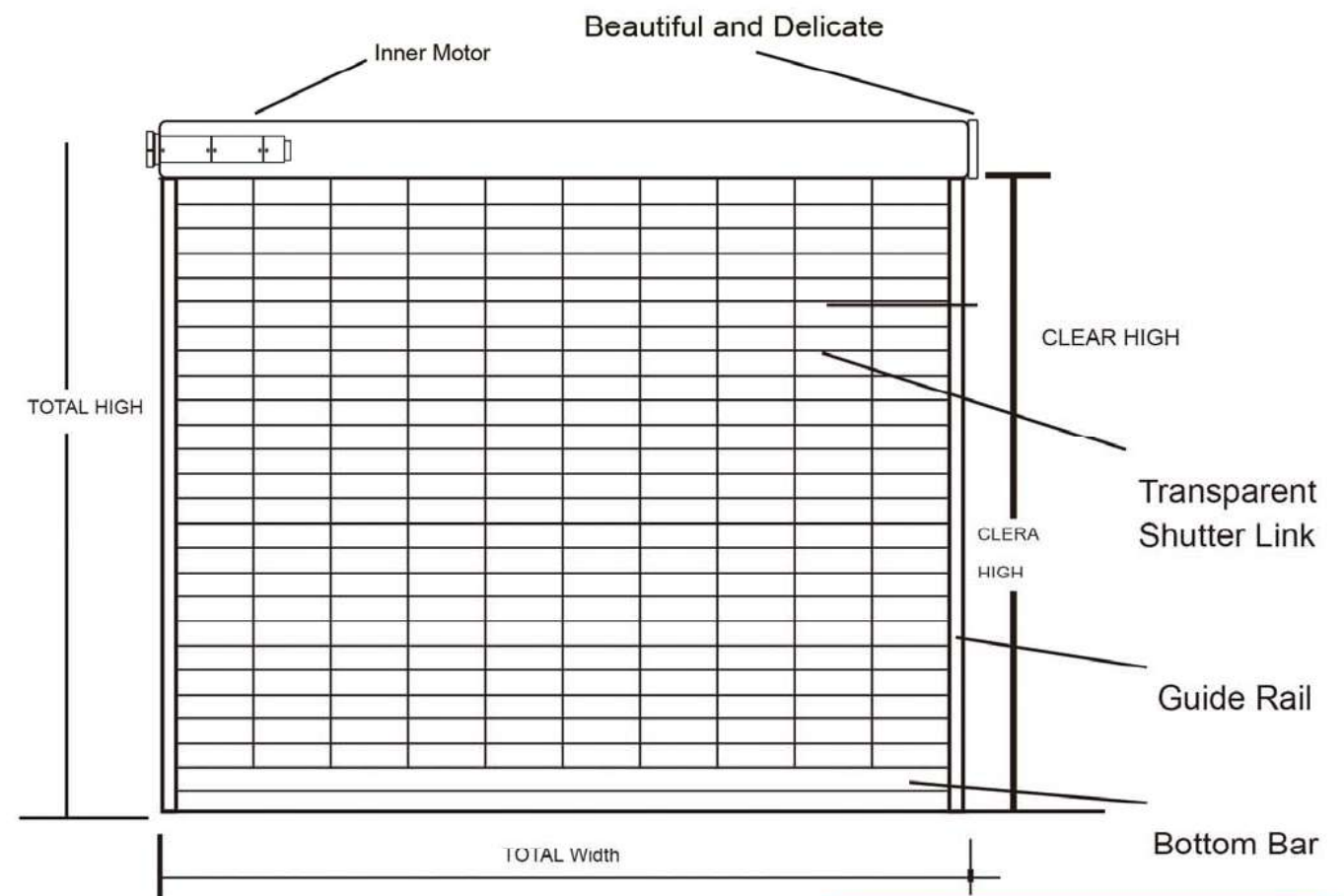

PC roller window and shutter make up by
 PC slat .aluminium tube. aluminium bottom bar.
 It is a new and fashion design for windows and shutters.
 It has small roller diameter by using inner motor operation.
 It is very welcome in office widows and shops

No.132, Let Wel Thondara U Myat San St., East Dagon
 Industrial Zone (2), South Dagon Tsp., Yangon, Myanmar
 E mail : citybm88@gmail.com
 +95 09 42114 9808 / +95 09 97205 7711